

# Richter Ball Control Valves

– Torque transmission free of play –

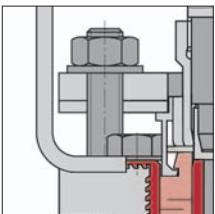
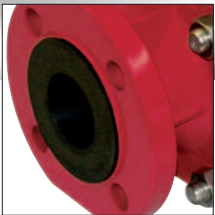
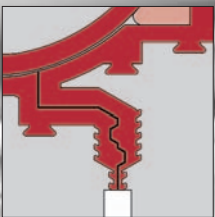
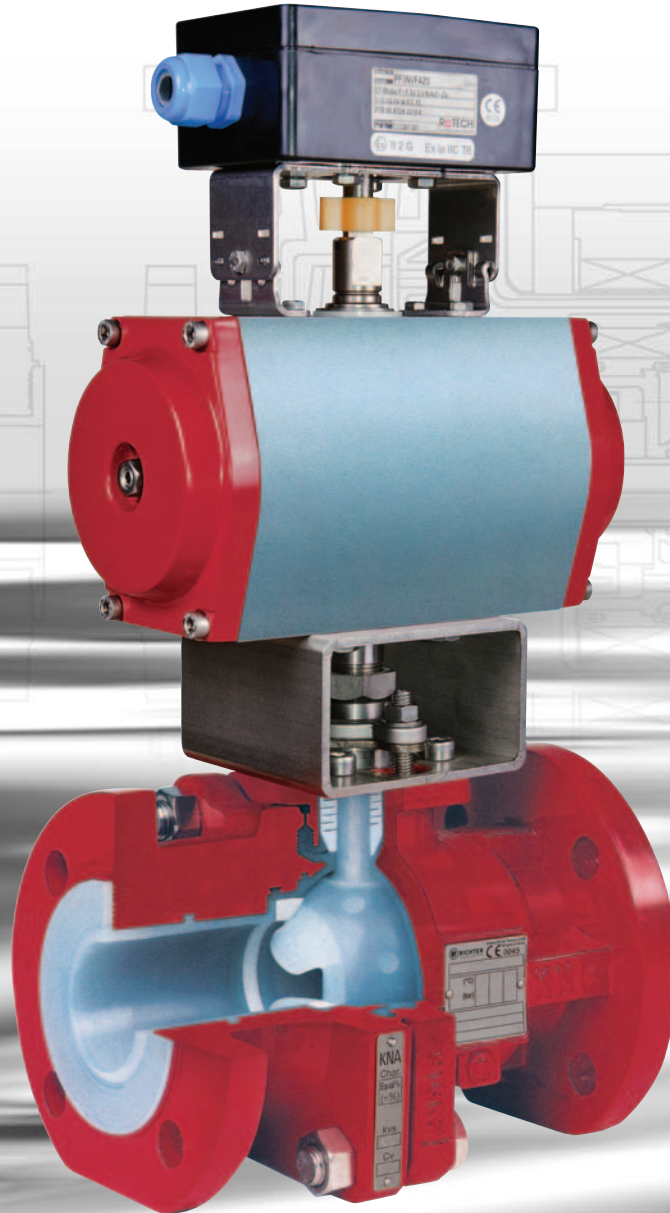

ISO/DIN, ASME/ANSI

Lining PFA, optionally PFA-P,  
PFA-HP, PFA-L

$k_{vs}$  0.1-400

ENVIPACK seal  
maintenance-free



**RICHTER**  
Process Pumps & Valves

**IDEX**  
FLUID & METERING

## Heavy-duty ball control valves with ENVIPACK stem seal

With the series KNR, KNRP (ISO/DIN) and KNAR, KNARP (ASME/ANSI), compact control valves with high flow control accuracy are available to plant operators. In many applications they are a very economical alternative to bellows-type sliding stem valves and rotary plug valves.

The ENVIPACK stem sealing, valve body and seat rings are identical to those of the shut-off ball valves KN and KNA, as are the selection of material and the pressure/temperature range. Advantages: minimum stocks of spare parts, subsequent conversion from a shut-off to a control valve.

### Product features

- Depending on the size, 3 to 6 finely graduated  $k_{VS}$ -values
- Equal percentage characteristics to DIN EN 60534, linear by means of positioner
- DN 15-200 (1/2" to 8")
- -60 to +200 °C (-75 to +400 °F), operating temperature see diagram on page 3
- Face-to-face to- ISO 5752-1/DIN EN 558-1(except from DN 200/8")
  - ASME/ANSI B 16.10-8, Cl.150
- Flanges to - ISO/DIN 7005-2 PN 16 (DN 200: PN 10), DN 25-80 (1"-3") optionally PN 25 with PB 16 bar (232 psi)
  - ASME/ANSI B16.5 Cl.150

### Type codes

	manual actuation	remote actuation
• ISO/DIN	KNR/...	KNRP/...
• ASME/ANSI short	KNAR/...	KNARP/...

### Lining

• PFA	.../F
• Antistatic PFA-L	.../F-L
• Highly permeation-resistant PFA-P	.../F-P
• Ultrapure (e.g. pharma applications PFA-HP)	.../F-HP

- ① **3.5 mm (1/7") thick lining made of pure PFA**
  - Vacuum-proof anchoring
  - Transparent, optimum quality assurance
  - **Optional 5 mm (1/5") wall thickness** (from DN 25/1")
  - Optionally antistatic lining PFA-L, PFA-HP ultrapure or PFA-P particularly highly permeation-resistant
- ② **Body made of ductile cast iron** EN-JS 1049/ASTM A395, absorbs the system and pipe forces
- ③ **Permanently tight body connection**
  - Also with frequent temperature changes
  - Sealing surface (3a) with full lining
  - **Labyrinth-like sealing (3b):** Maximum surface pressure between the body halves
  - Body halves center themselves exactly to each other owing to the fit (3c)
  - **Almost metallic stop (3d)** absorbs pipe forces, see below
- ④ **Resilient PTFE seat rings** permanent pre-tension of the ball, gas-tight seal
- ⑤ **Richter ENVIPACK stem sealing with active stainless steel packing gland follower (5a)**
  - Proven 100,000 times over
  - Conformity with German Clean Air Code (TA Luft), self-adjusting
  - Bellows-type packing insert (5b), gas-tight to EN 12266, leakage rate A
  - Virtually maintenance-free even with frequent hot/cold cycles
  - Visual inspection of the pre-loading action
  - Controlled adjustment from outside (5c)

## Why "Almost metallic stop" instead of "metallic stop"?

### Richter's "virtually metal-to-metal contact", permanently tight:

The body lining (3d) decreases to about 0.5 mm (0.02") permitting the inner flange connection to be retightened in the event of a leak in the sealing area. However, leakage is most improbable thanks to the labyrinth-type design (3b) typical of Richter.

### What are the disadvantages of lined valves with "metallic stop"?

The body halves are bolted together with full metallic contact (3m).

### Retightening is not possible, any leak that occurs cannot be stopped.

The cavity between the lining and the metallic contact also prevents the early detection of any leak.

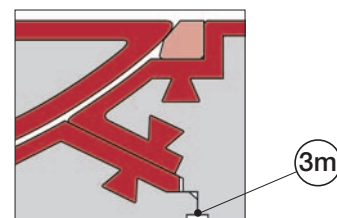
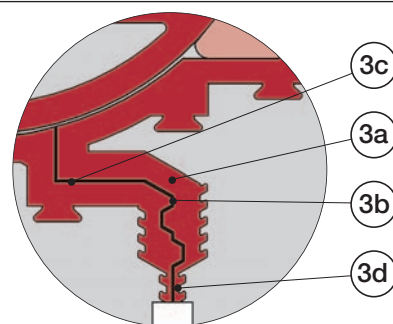

Thick-walled PFA lining  
 Particularly low-cavity  
 Maintenance-free

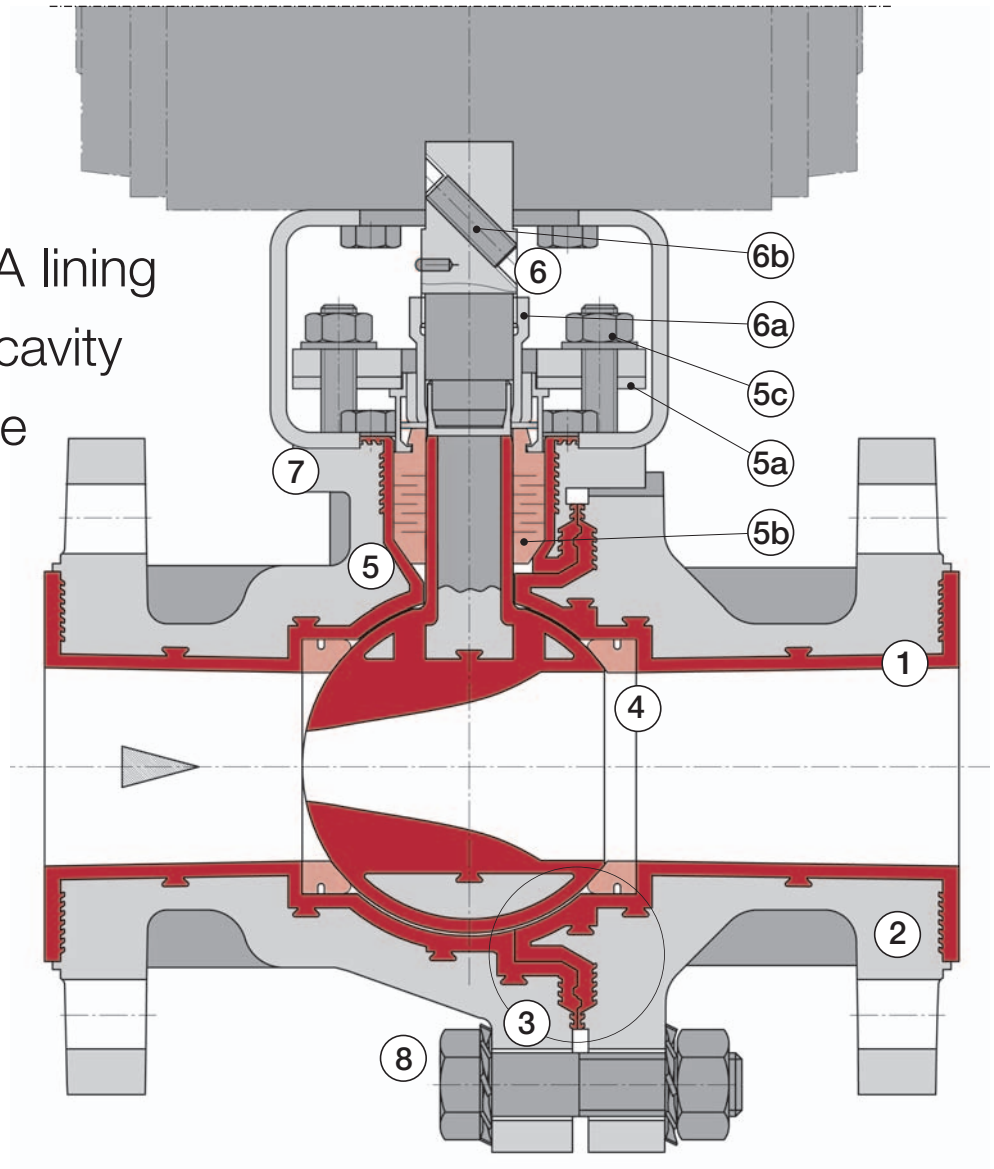

- ⑥ **Transmission of torque free of play** with sleeve nut (6a) and setscrew (6b)
- ⑦ **Universal ISO 5211 connection**
- ⑧ **External corrosion protection**  
 Epoxy coating. Packing gland, lever, bolts/nuts made of stainless steel.

**Pressure/temperature range**

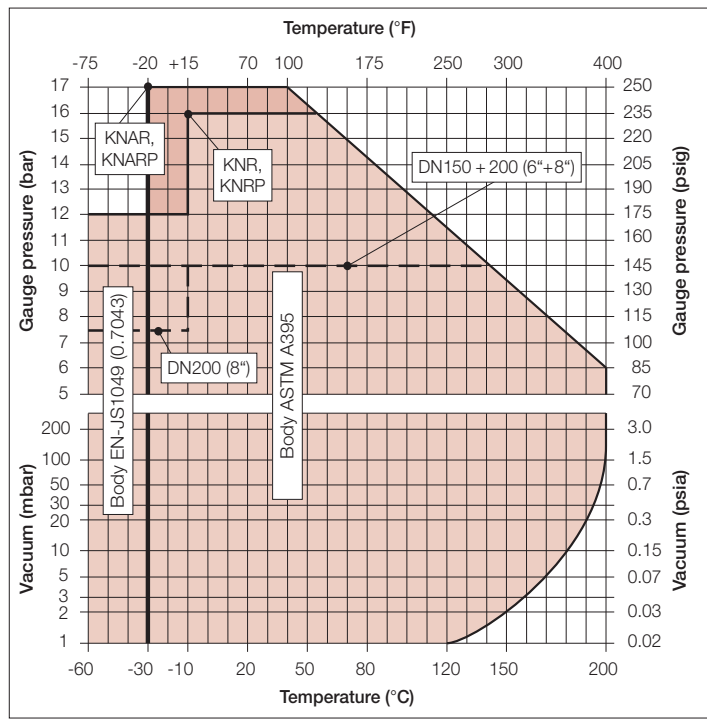

**Body EN-JS 1049 (0.7043)/PFA:**  
 -60 °C (-75 °F) to +200 °C (400 °F); max. 16 bar (235 psi) as per AD 2000  
**Body ASTM A395/PFA:**  
 -30 °C (-20 °F) to +200 °C (400 °F); max. 17.2 bar (250 psi) as per ASME B16.42  
**For low-temperature applications please observe the local regulations!**  
 Operating temperatures below -10 °C (15 °F): special material for ball/stem core

## Components and materials

Item	Designation	Material
101	Main body	Ductile cast iron EN-JS1049/ASTM A395, (DN 1", 1 1/2", 2" ASME/ANSI optionally investment cast stainless steel
102	Body end piece	1.4408/CF8M), PFA-lined, optionally PFA-L antistatic, PFA-HP ultrapure or PFA-P highly permeation-resistant
201	Ball/stem unit	Stainless steel, PFA-lined, optionally PFA-L antistatic, PFA-HP ultrapure or PFA-P highly permeation-resistant
401	Seat rings	PTFE
403	Packing bellows	PTFE
405/1	Thrust ring	Stainless steel
502	Spring gland follower*	Stainless steel
503	Packing gland follower	Stainless steel
510	Bracket	Stainless steel
526	Retaining washer	Stainless steel
557	Grounding spring washer	Stainless steel
804	Coupling, play-free	Stainless steel
850	Actuator	to customer request
904/4	Setscrew	Stainless steel
w/o No.	Screws (A4-70) & nuts	Stainless steel

\* for DN 80, 100, 150, 200 (3", 4", 6", 8") two spring gland follower

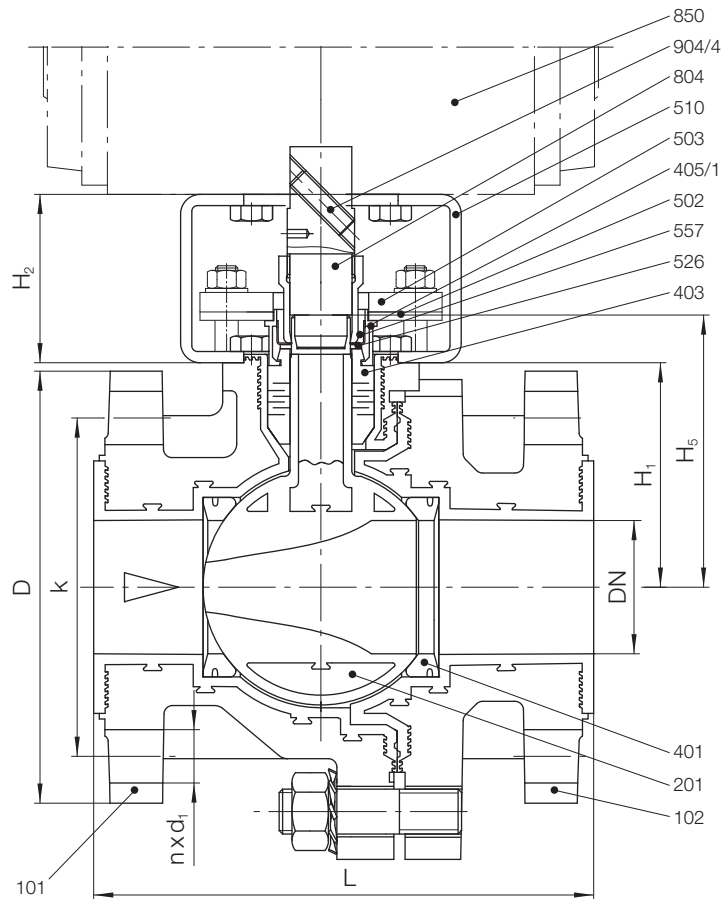

## Dimensions and weights

### Series KNRP, KNR (ISO/DIN): Installation dimensions and approx. weights

Face-to-face ISO 5752 series 1 (DIN 3202 F1), flanges ISO 7005-2\*\*

DN		L		D		k		nxd <sub>1</sub>		EN ISO	H <sub>1</sub>		H <sub>5</sub>		H <sub>2</sub>		HL***		H****		Weights without actuator	
mm	inch	mm	inch	mm	inch	mm	inch	mm	inch	5211	mm	inch	mm	inch	mm	inch	mm	inch	mm	inch	kg	lbs
15	1/2"	130	5.12	95	3.74	65	2.56	4x14	4x0.55	F05	50	1.97	60	2.36	60	2.36	179	7.0	130	5.12	5.6	12.3
20	3/4"	150	5.91	105	4.13	75	2.95	4x14	4x0.55	F05	50	1.97	60	2.36	60	2.36	179	7.0	130	5.12	6	13.2
25	1"	160	6.30	115	4.53	85	3.35	4x14	4x0.55	F05	50	1.97	60	2.36	60	2.36	179	7.0	130	5.12	6	13.2
40	1 1/2"	200	7.87	150	5.91	110	4.33	4x19	4x0.75	F07	77	3.03	94	3.70	60	2.36	260	10.2	155	6.10	14	30.9
50	2"	230	9.06	165	6.5	125	4.92	4x19	4x0.75	F07	80	3.15	97	3.82	60	2.36	260	10.2	155	6.10	16	35.3
80	3"	310	12.2	200	7.87	160	6.30	8x19	8x0.75	F10	118	4.65	140	5.51	80	3.15	413	16.3	180	7.09	35	77
100	4"	350	13.8	220	8.66	180	7.09	8x19	8x0.75	F10	134	5.28	156	6.14	80	3.15	413	16.3	195	7.68	55	121
150	6"	480	18.9	285	11.2	240	9.45	8x23	8x0.91	F12	184	7.24	215	8.46	100	3.94	515*	20.3*	265	10.4	104	229
200	8"	457	18	340	13.4	295	11.61	8x23	8x0.91	F12	184	7.24	215	8.46	100	3.94	515*	20.3*	265	10.4	125	276

\* DN 150 (6") and 200 (8") manual actuation: At Δp > approx. 2 bar (29 psi) a worm gear is recommended instead of the hand lever. Details on request.

\*\* On request: drilled to ASME/ANSI B16.5 Cl.150, JIS 10K

\*\*\* Dimension HL not shown: length hand lever from centre of ball/stem unit (part 201)

\*\*\*\* Dimension H not shown: height from centre of ball to upper edge of lever

### Series KNARP, KNAR (ASME/ANSI): Installation dimensions and approx. weights

Face-to-face ASME/ANSI B16.10 short, flanges ASME/ANSI B16.5 Cl.150\*\*

DN		L		D		k		nxd <sub>1</sub>		EN ISO	H <sub>1</sub>		H <sub>5</sub>		H <sub>2</sub>		HL***		H****		Weights without actuator	
mm	inch	mm	inch	mm	inch	mm	inch	mm	inch	5211	mm	inch	mm	inch	mm	inch	mm	inch	mm	inch	kg	lbs
15	1/2"	130	5.12	89	3.5	60.5	2.38	4x16	4x5/8	F05	50	1.97	60	2.36	60	2.36	179	7.0	130	5.12	5.6	12.3
20	3/4"	150	5.91	98.5	3.88	70	2.76	4x16	4x5/8	F05	50	1.97	60	2.36	60	2.36	179	7.0	130	5.12	6	13.2
25	1"	127	5.0	108	4.25	79.5	3.13	4x16	4x5/8	F05	50	1.97	60	2.36	60	2.36	179	7.0	130	5.12	5.6	12.3
40	1 1/2"	165	6.5	127	5.0	98.5	3.88	4x16	4x5/8	F07	77	3.03	94	3.70	60	2.36	260	10.2	155	6.10	12	26.4
50	2"	178	7.0	152.5	6.0	120.5	4.75	4x19	4x3/4	F07	80	3.15	97	3.82	60	2.36	260	10.2	155	6.10	14.5	32
80	3"	203	8.0	190.5	7.5	152.5	6.0	4x19	4x3/4	F10	118	4.65	140	5.51	80	3.15	413	16.3	180	7.09	33.5	74
100	4"	229	9.0	229	9.02	190.5	7.5	8x19	8x3/4	F10	134	5.28	156	6.14	80	3.15	413	16.3	195	7.68	50	110
150	6"	267	10.5	279.5	11.0	241.5	9.51	8x23	8x7/8	F12	184	7.24	215	8.46	80	3.15	515*	20.3*	265	10.4	91	201
200	8"	457	18	343	13.5	298.5	11.75	8x23	8x7/8	F12	184	7.24	215	8.46	80	3.15	515*	20.3*	265	10.4	125	276

\* DN 150 (6") and 200 (8") manual actuation: At Δp > approx. 2 bar (29 psi) a worm gear is recommended instead of the hand lever. Details on request.

\*\* On request: drilled to JIS 10K, ISO 7005-2

\*\*\* Dimension HL not shown: length hand lever from centre of ball/stem unit (part 201)

\*\*\*\* Dimension H not shown: height from centre of ball to upper edge of lever

## High control accuracy, finely graduated $k_{VS}$ -values

Flow values  $k_v$  (%) depend on the control range, for equal percentage characteristics with a rangeability of 1:25

The medium flow starts at a defined degree of stem rotation, see "Start".

DN		$k_v$ (%)		5,5	7,6	10,5	14,5	20,0	27,6	38,1	52,5	72,5	100	
mm	inch	Control range (% open)	Shut	Start	10	20	30	40	50	60	70	80	90	100
15, 20, 25	1/2", 3/4", 1"	Stem angle of rotation (degrees)	0	25.0	31.5	38.0	44.5	51.0	57.5	64.0	70.5	77.0	83.5	90
40	1 1/2"		0	29.0	35.1	41.2	47.3	53.4	59.5	65.6	71.7	77.8	83.9	90
50	2"		0	21.0	27.9	34.8	41.7	48.6	55.5	62.4	69.3	76.2	83.1	90
80	3"		0	17.0	24.3	31.6	38.9	46.2	53.5	60.8	68.1	75.4	82.7	90
100	4"		0	16.5	23.8	31.2	38.5	45.9	53.2	60.6	67.9	75.3	82.6	90
150, 200	6", 8"		0	12.0	19.8	27.6	35.4	43.2	51.0	58.8	66.6	74.4	82.2	90

\*Note it is recommended to control in the range of approx. 20 to 90 % of the effective control range, so using approx. 7-75 % of the  $k_{VS}$  value.

### Available $k_{VS}$ -values (m<sup>3</sup>/h)

DN		$k_{VS}$ (Cv)													
mm	inch	0.1	0.5	0.8	1.6	4	8	14	20						
15, 20, 25	1/2", 3/4", 1"	(0.12)	(0.58)	(0.9)	(1.9)	(4.7)	(9.3)	(16.3)	(23.3)						
40	1 1/2"							16	25	40					
								(18.6)	(29.1)	(46.6)					
50	2"							16	25	60					
								(18.6)	(29.1)	(46.6)	(69.9)				
80	3"									40	80	120	160		
										(46.6)	(93.2)	(139.8)	(186.4)		
100	4"									60	100	160	250		
										(69.9)	(116.5)	(186.4)	(291.3)		
150, 200*	6", 8" *											160	250	400	
												(186.4)	(291.3)	(466)	

\* DN 200 (8") with reduced bore, control ball DN 150 (6")

Formula for conversion:

$$Cv \text{ (US gpm)} = k_{VS} \text{ (m}^3\text{/h)} \cdot 1.165$$

$$Cv \text{ (Imp gpm)} = k_{VS} \text{ (m}^3\text{/h)} \cdot 0.971$$

### z-values for 75 % duty ( $k_v/k_{VS} = 0.75$ )

DN		z-values														
mm	inch	0.68	0.68	0.65	0.6	0.6	0.6	0.58	0.43							
15, 20, 25	1/2", 3/4", 1"															
40	1 1/2"							0.53	0.5	0.35						
50	2"										0.39	0.32				
80	3"										0.42	0.31	0.29	0.22		
100	4"											0.3	0.27	0.24	0.16	
150, 200*	6", 8" *													0.15	0.13	0.08

\* DN 200 (8") with reduced bore, control ball DN 150 (6")

## Operating torques

Operating torques (incl. breakaway torques)

DN		Operating torques									
mm	inch	$\Delta p$ 3 bar/45 psi		$\Delta p$ 6 bar/85 psi		$\Delta p$ 10 bar/145 psi		$\Delta p$ 16 bar/235 psi		max. admissible	
		Nm	in-lbs	Nm	in-lbs	Nm	in-lbs	Nm	in-lbs	Nm	in-lbs
15	1/2"	8	71	8	71	8	71	10	89	70	620
20	3/4"	8	71	8	71	8	71	10	89	70	620
25	1"	12	106	12	106	12	106	12	106	70	620
40	1 1/2"	20	221	20	221	20	221	25	266	225	1990
50	2"	25	266	25	266	25	266	30	310	225	1990
80	3"	60	531	60	531	65	575	80	708	500	4425
100	4"	80	708	80	708	90	797	120	1062	500	4425
150	6"	200	1770	250	2213	350	3098	-	-	2200	19470
200	8"	200	1770	250	2213	350	3098	-	-	2200	19470

All operating torques: test medium water 20 °C, seat rings pure PTFE.

The operating and breakaway torques may differ depending on the medium (dry gases, crystallising media, oil contents etc.).

## Richter's speciality: customised problem solutions

Ask Richter when you are looking for a solution to your problem! In addition to the selection of common special designs presented here, we also offer many other specialities.

**Stainless steel heating jacket**  
for all standard heat transfer media

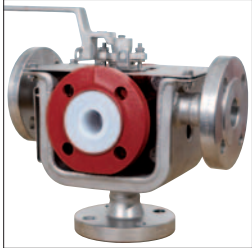

**Stainless steel body with PFA lining**  
ASME/ANSI face-to-face 1"-2"

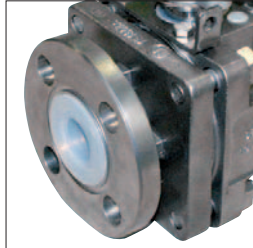

**Standard with the manual actuation version: lockable stainless steel hand lever**

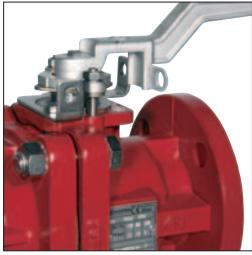

**Linings antistatic, highly permeation-resistant, FDA-compliant**

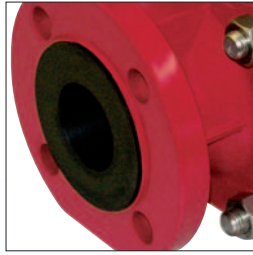

**Extra thick-walled lining 5 mm**  
for highly permeating media

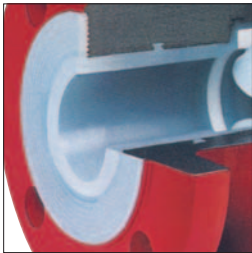

### PFA-lined sliding stem control valves

- $k_v$  0.05-155
- bellows sealed
- single-piece valve body
- -60 to +200 °C (-75 to +400 °F)
- see separate publications RSS (remote actuation) and HVR (manual actuation)



Presented by:

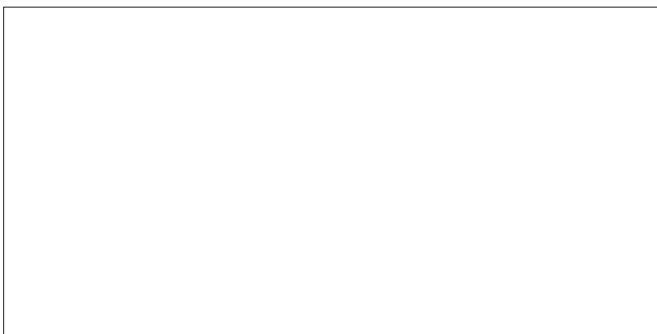

**Richter Chemie-Technik GmbH**

Otto-Schott-Str. 2, D-47906 Kempen, Germany

Tel. +49(0)21 52/146-0, Fax +49(0)21 52/146-190

[www.richter-ct.com](http://www.richter-ct.com), [richter-info@idexcorp.com](mailto:richter-info@idexcorp.com)